

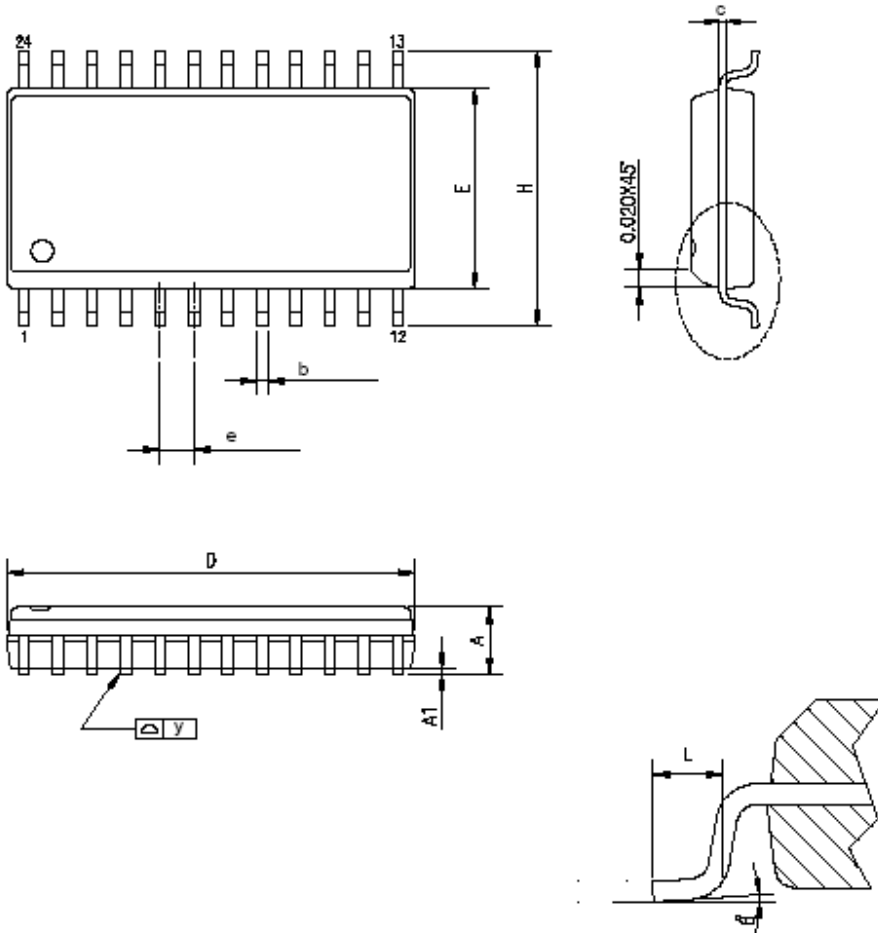

24L SOP(300mil) Package Outline :



Symbol	Dimension in mm			Dimension in inch		
	Min	Nom	Max	Min	Nom	Max
A	—	—	2.65	—	—	0.104
A1	0.10	—	—	0.004	—	—
b	—	0.41	—	—	0.016	—
c	—	0.25	—	—	0.010	—
D	15.20	—	15.70	0.598	—	0.618
E	7.39	—	7.60	0.291	—	0.299
H	10.01	—	10.64	0.394	—	0.419
e	—	1.27	—	—	0.050	—
L	0.40	—	1.27	0.016	—	0.050
y	—	—	0.10	—	—	0.004
θ	0°	—	8°	0°	—	8°

Note :

1. Dimension D & E do not include mold protrusion. D and E are maximum plastic body size dimension include mold mismatch.
2. Dimension b does not include dambar protrusion.